

EN.IK.PEM.500

MARCH 2022

Revision 01.A.001

# APLISENS<sup>®</sup>

## CONFIGURATION MANUAL

ELECTROMAGNETIC FLOWMETER

### PEM-500

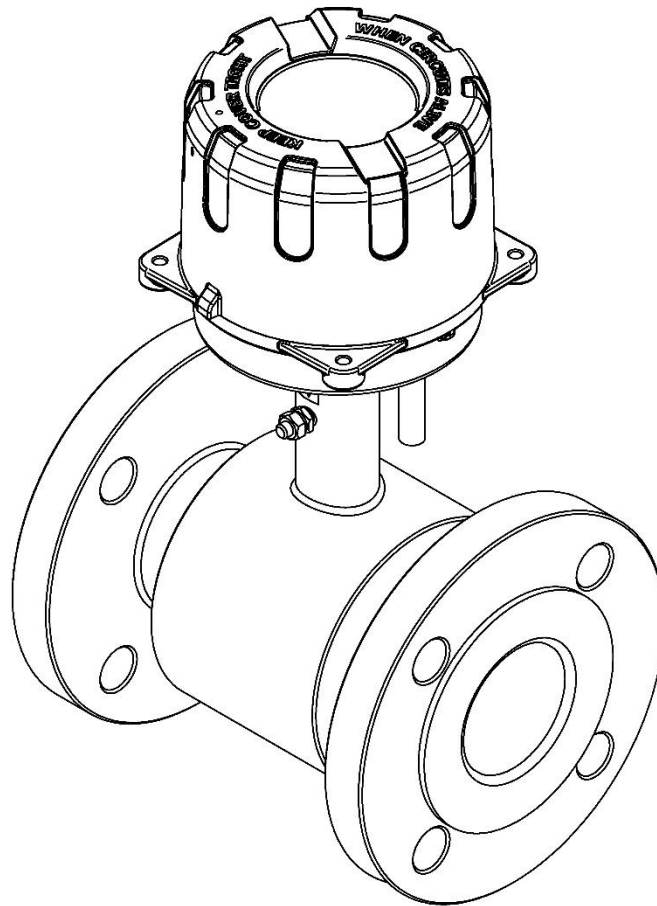

APLISENS S.A., 03-192 Warsaw, Morelowa 7 St

tel. +48 22 814 07 77; fax +48 22 814 07 78

[www.aplisens.com](http://www.aplisens.com), e-mail: [export@aplisens.com](mailto:export@aplisens.com)

PRODUCT CODE – see p. 5.2 (Flowmeter identification in USER'S MANUAL).



The QR code or link identifies the flowmeter and provides quick access to the following documentation on the manufacturer's website: user's manual, MODBUS manual, configuration manual, declarations of conformity and copies of certificates.

## PEM-500

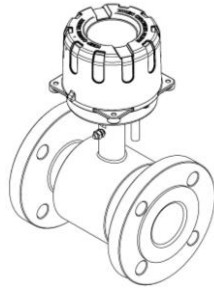
<https://aplisens.com/pem-500.html>



## Symbols used

Symbol	Description
	Warning to proceed strictly in accordance with the information contained in the documentation in order to ensure the safety and full functionality of the device.
	Information particularly useful during installation and operation of the device.

### BASIC REQUIREMENTS AND SAFE USE



The manufacturer will not be liable for damage resulting from incorrect installation, failure to maintain a suitable technical condition of the device or use of the device other than for its intended purpose.

Installation should be carried out by qualified staff having the required authorizations to install electrical and I&C equipment. The installer is responsible for performing the installation in accordance with manual as well as with the electromagnetic compatibility and safety regulations and standards applicable to the type of installation.

In systems with I&C equipment, in case of leakage, there is a danger to staff due to the medium under pressure. All safety and protection requirements must be observed during installation, operation and inspections.

If a malfunction occurs, the device should be disconnected and handed over to the manufacturer for repair.



In order to minimize the risk of malfunction and associated risks to staff, the device is not to be installed or used in particularly unfavourable conditions, where the following hazards occur:

- possible mechanical impacts, excessive shocks and vibration;
- excessive temperature fluctuation;
- water vapour condensation, dusting, icing.

Changes made to the manufacturing of products may be introduced before the paper version of the manual is updated. The up-to-date manuals are available on the manufacturer's website: [www.aplisens.com](http://www.aplisens.com).

## TABLE OF CONTENTS

<b>1. INTRODUCTION</b> .....	<b>5</b>
<b>2. SAFETY</b> .....	<b>5</b>
<b>3. FLOWMETER CONFIGURATION</b> .....	<b>6</b>
<b>3.1. Configuration and reading parameters</b> .....	<b>6</b>
<b>3.2. Menu structure</b> .....	<b>7</b>
<b>3.3. Proview of data on a virtual display</b> .....	<b>16</b>
<b>4. ADDITIONAL INFORMATION</b> .....	<b>17</b>
<b>4.1. History of revisions</b> .....	<b>17</b>
<b>4.2. History of revisions</b> .....	<b>17</b>

## LIST OF DRAWINGS

<b>Figure 1.</b> Configuration of Raport 2 software necessary for proper communication with the flowmeter. ....	<b>6</b>
<b>Figure 2.</b> View of the “Basic” tab in Raport 2.....	<b>7</b>
<b>Figure 3.</b> View of the “Advanced” tab in Raport 2. ....	<b>8</b>
<b>Figure 4.</b> View of the “Outputs” tab in Raport 2.....	<b>9</b>
<b>Figure 5.</b> View of the “Input” tab in Raport 2. ....	<b>9</b>
<b>Figure 6.</b> View of the “Filtering” tab in Raport 2.....	<b>10</b>
<b>Figure 7.</b> View of the “Dosing” tab in Raport 2. ....	<b>11</b>
<b>Figure 8.</b> View of the “Modbus” tab in Raport 2.....	<b>11</b>
<b>Figure 9.</b> View of the “Archives” tab in Raport 2.....	<b>12</b>
<b>Figure 10.</b> View of the “Information” tab in Raport 2. ....	<b>12</b>
<b>Figure 11.</b> View of the “Functions” tab in Raport 2.....	<b>13</b>
<b>Figure 12.</b> View of the “Statuses” tab in Raport 2. ....	<b>13</b>
<b>Figure 13.</b> View of the “Diagnostics” tab in Raport 2.....	<b>15</b>
<b>Figure 14.</b> Screenshot presenting the current preview of the virtual display of the PEM-500 flowmeter in Raport 2.....	<b>16</b>

## LIST OF TABLES

<b>Table 1.</b> Error statuses defined in “Raport 2” and their possible causes. ....	<b>14</b>
--	-----------

## 1. INTRODUCTION

The configuration manual covers the electromagnetic flowmeter **PEM-500**.

The manual contains data, tips and general recommendations for configuration of the flowmeter.



Before the proceeding with the flowmeter follow the user manual EN.IO.PEM.500 and follow the MODBUS manual EN.IM.PEM.500. These manuals are available on the manufacturer's website [www.aplisens.com](http://www.aplisens.com).

## 2. Safety



- The installation and start-up of the flowmeter and all activities related to its operation must be carried out after having thoroughly read and understood the contents of this configuration manual and the related manual.
- Installation and maintenance should be carried out by qualified staff holding the required licenses to install electrical and measuring devices.
- The device shall be used according to its intended purpose in line with the permissible parameters specified on the nameplate.
- The protecting elements used by the manufacturer to ensure flowmeter safety may be less effective if the device is operated in a manner inconsistent with its intended use.
- Before installing or disassembling the device, it is absolutely necessary to disconnect it from the power source.
- No repairs or alterations of the flowmeter electronic system are permitted. Damage assessment and the possible repair may only be performed by the manufacturer or its authorized representative.
- Do not use instruments if damaged. In case of malfunction, the device must be put out of operation.

### 3. FLOWMETER CONFIGURATION

#### 3.1. Configuration and reading parameters.

The configuration and reading of the flowmeter parameters are done via the RS485 interface and MODBUS RTU protocol using a PC equipped with RS485/USB converter and RAPORT 2 or other software, interfacing with the meter registers according to the interface documentation.

The installation of the RAPORT 2 software is described in the user manual: "IO.RAPORT 2" available at [www.aplisens.com](http://www.aplisens.com).



Any HMI panel running as MODBUS master can also be used to visualize data.

In order to start working with the software, it is necessary to configure the parameters responsible for communication with the flowmeter as shown in Figure 1:

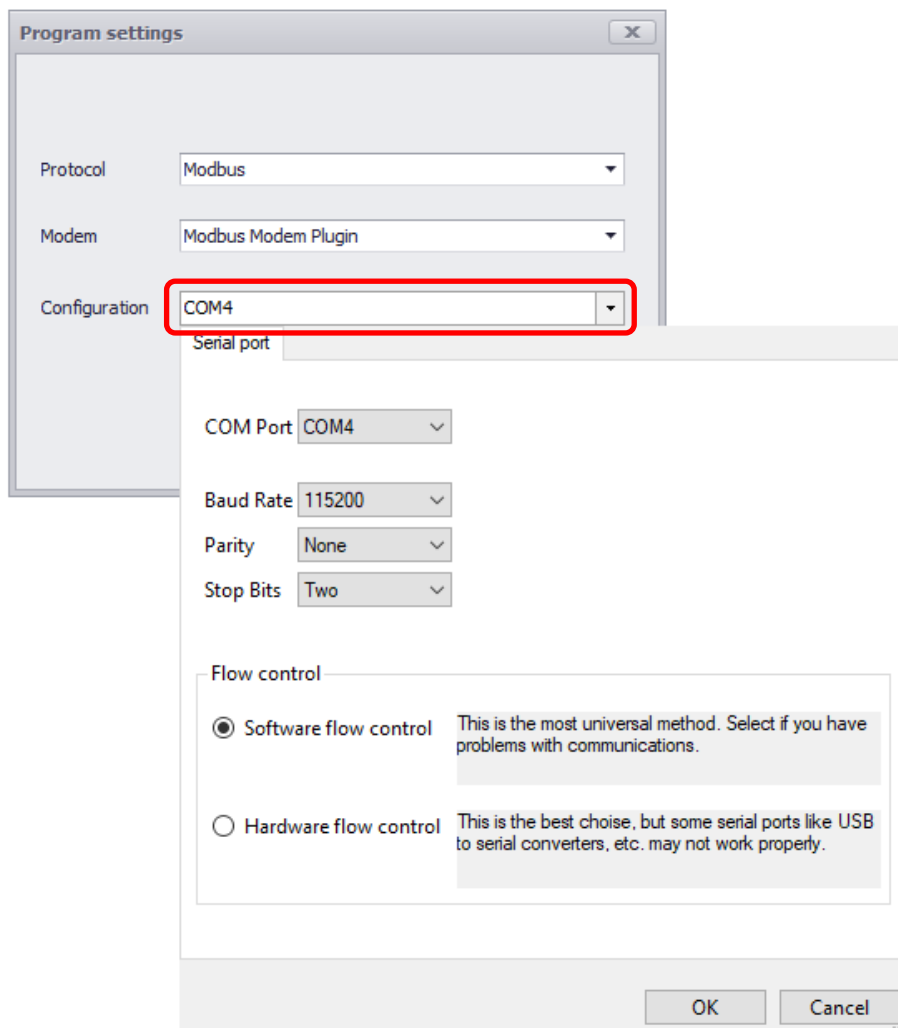

**Figure 1.** Configuration of Raport 2 software necessary for proper communication with the flowmeter.

Once you have entered the above settings, search for the flowmeter. The software enables searching in several ways:

- Click on the icon  on the taskbar;
- Press Ctrl+I on your keyboard;
- Select „Device” → „Device identification”.

The software starts searching. Flowmeters identified by the software will be listed one by one.

### 3.2. Menu structure.

After searching for the flowmeter and reading the configuration, the user has two tabs available in the program menu:

- „Float value chart“;
- „PEM500 Basic“, which consist of 12 tabs:

- **Basic**

The tab is used to define the basic functions of the device.

The screenshot shows the 'Basic' configuration tab with the following settings:

- Fast empty pipe detection (Zero threshold value: 1.100 m3/h)
- Fast empty pipe detection (Fast empty pipe detection threshold: 0.100, Counter fast empty pipe detection: 4)
- Exact empty pipe detection (Empty pipe detection value: 50000 Ω)
- Low flow rate (Low flow rate value: 1.600 m3/h)
- Aggressive measuring method
- Totalizers unit: m<sup>3</sup> (Totalizers display format: Floating (+12.345))
- Flow unit: m<sup>3</sup>/h (Flow display format: Floating (+12.345))
- Flow rate unit: m/s (Flow rate display format: Floating (+12.345))
- Text unit: --- (Factor unit: 1.000 m3/---)
- Main screen: Main totalizer with device statuses
- Screen skip time: 0 s (Language: English)
- Date: 02.04.2010
- Time: 00:41:58
- User menu access pin: 1000

Buttons: Set, Set : 02.16.2022 09:54:40, Read, Write

Figure 2. View of the “Basic” tab in Raport 2.

- **Advanced**

The “advanced” tab allows the user to set pipe diameter, sensor type and activate individual alarms.

Basic	Advanced	Output	Input	Filtering	Dosing	Modbus	Archives	Information	Functions	Statuses	Diagnostics
-------	----------	--------	-------	-----------	--------	--------	----------	-------------	-----------	----------	-------------

Pipe diameter:

Sensor type:

Active alarms

- Empty pipe detected
- Unfilled pipe detected
- Low flow rate detected
- Frontend error
- Sensor error
- Internal memory error
- Coil error
- Alarm for a flow greater than threshold value      Qmax  m3/h
- Alarm for a flow lower than threshold value      Qmin  m3/h
- Alarm for a flow rate greater than threshold value      Vmax  m/s
- Alarm for a flow rate lower than threshold value      Vmin  m/s
- Alarm for exceeding the positive totalizer threshold value      TP  m3
- Alarm for exceeding the negative totalizer threshold value      TM  m3

Admin access pin:

**Figure 3.** View of the “Advanced” tab in Raport 2.



• **Output**

The tab makes it possible to activate and adjust the output parameters concerning:

- Current loop 4-20 mA;
- Pulse output;
- Status output.



The PEM-500 flowmeter has one physical status output, so the “Status output 2” is inactive.

Figure 4. View of the “Outputs” tab in Raport 2.

• **Input**

The tab makes it possible to activate the binary input, set the operation mode as well as the delay time.

Figure 5. View of the “Input” tab in Raport 2.

- **Filtering**

The “Filtering” tab enables the user to adjust the filtering parameters, i.e.:

- LCD display filter;
- Current loop 4-20 mA filter;
- Pulse output filter;
- MODBUS output filter;
- Prefilter (0-10).

The screenshot shows the 'Filtering' tab selected in a software interface. The interface has a top navigation bar with tabs: Basic, Advanced, Output, Input, Filtering (selected), Dosing, Modbus, Archives, Information, Functions, Statuses, and Diagnostics. Below the tabs are four filter configuration sections:

- LCD display filter:** Mode (Damping), Time (0 s).
- Current loop 4-20 filter:** Mode (Damping), Time (0 s).
- Pulse output filter:** Mode (Damping), Time (0 s).
- MODBUS output filter:** Mode (Average), Time (0 s).

To the right of these sections is a **Prefilter** section with a **Level** slider set to 6 and a corresponding input box. At the bottom right are **Read** and **Write** buttons.

**Figure 6.** View of the “Filtering” tab in Raport 2.

- **Dosing**

The tab allows to adjust the parameters of the dosing function.



“Channel D2” is not physically implemented. Any changes or settings made to this field will not affect the operation of the system.

Figure 7. View of the “Dosing” tab in Raport 2.

- **Modbus**

The tab allows to adjust the parameters for Modbus communication.

Figure 8. View of the “Modbus” tab in Raport 2.

- **Archives**

The tab is used to view the event and measurement archive. The device can record 8128 events and 8128 measurements.

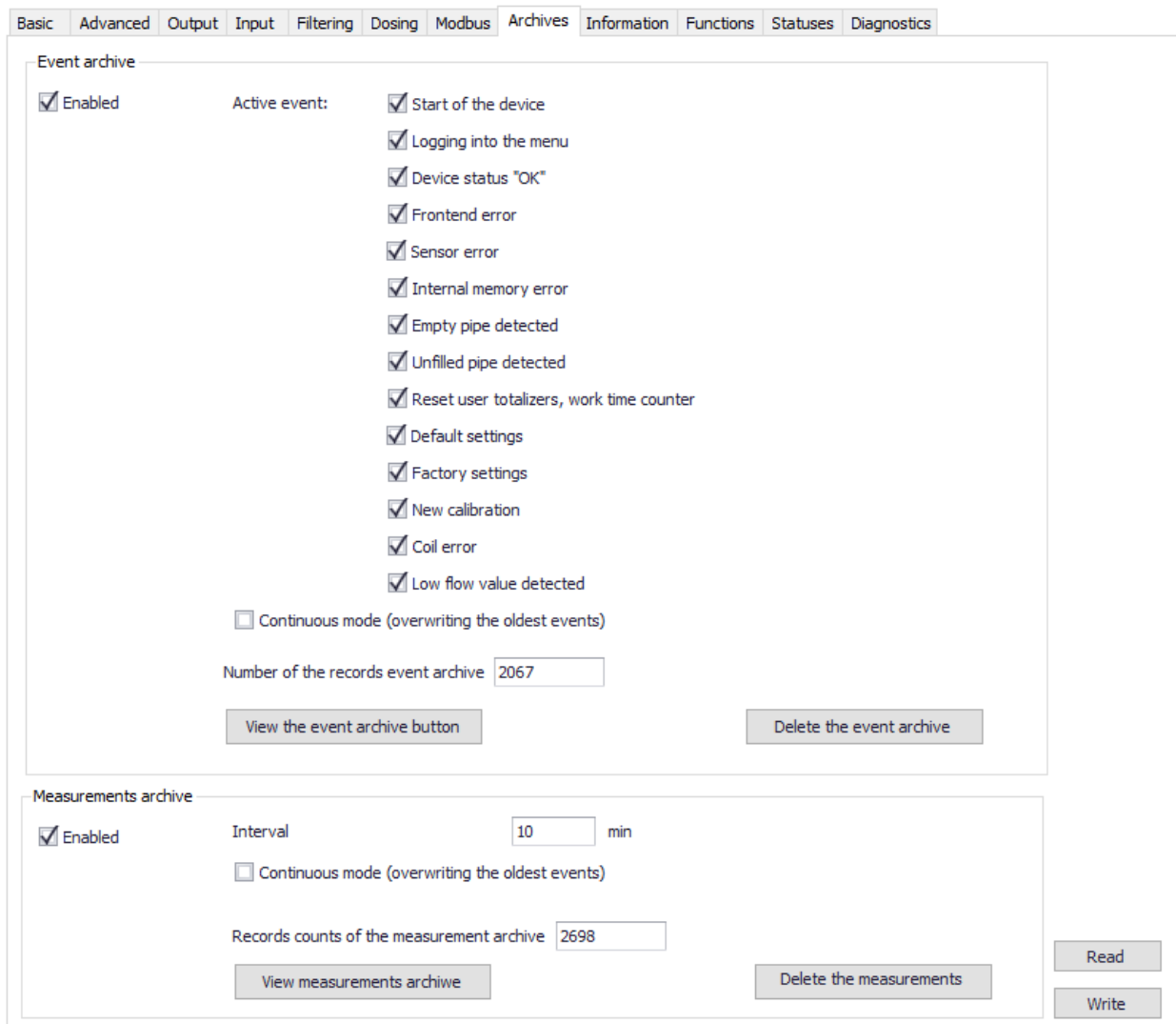

**Figure 9.** View of the “Archives” tab in Raport 2.

- **Information**

The tab contains information about the basic data of the flowmeter, including serial number, hardware version and software version.



**Figure 10.** View of the “Information” tab in Raport 2.

• **Functions**

The tab allows to reset:

- user totalizers;
- user work counter time;
- device errors.

It also allows to:

- set default parameters;
- set factory settings.

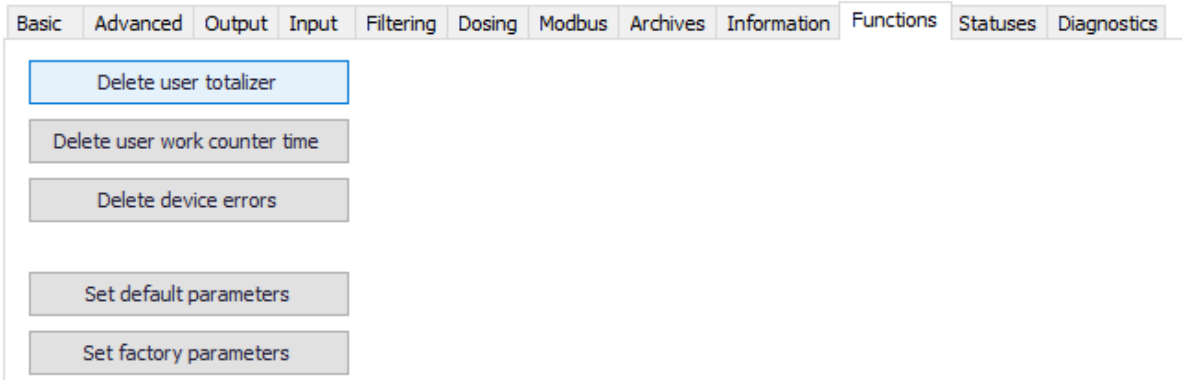

Figure 11. View of the “Functions” tab in Raport 2.

• **Statuses**

The tab provides the status of status inputs/outputs and shows possible errors of the flowmeter.

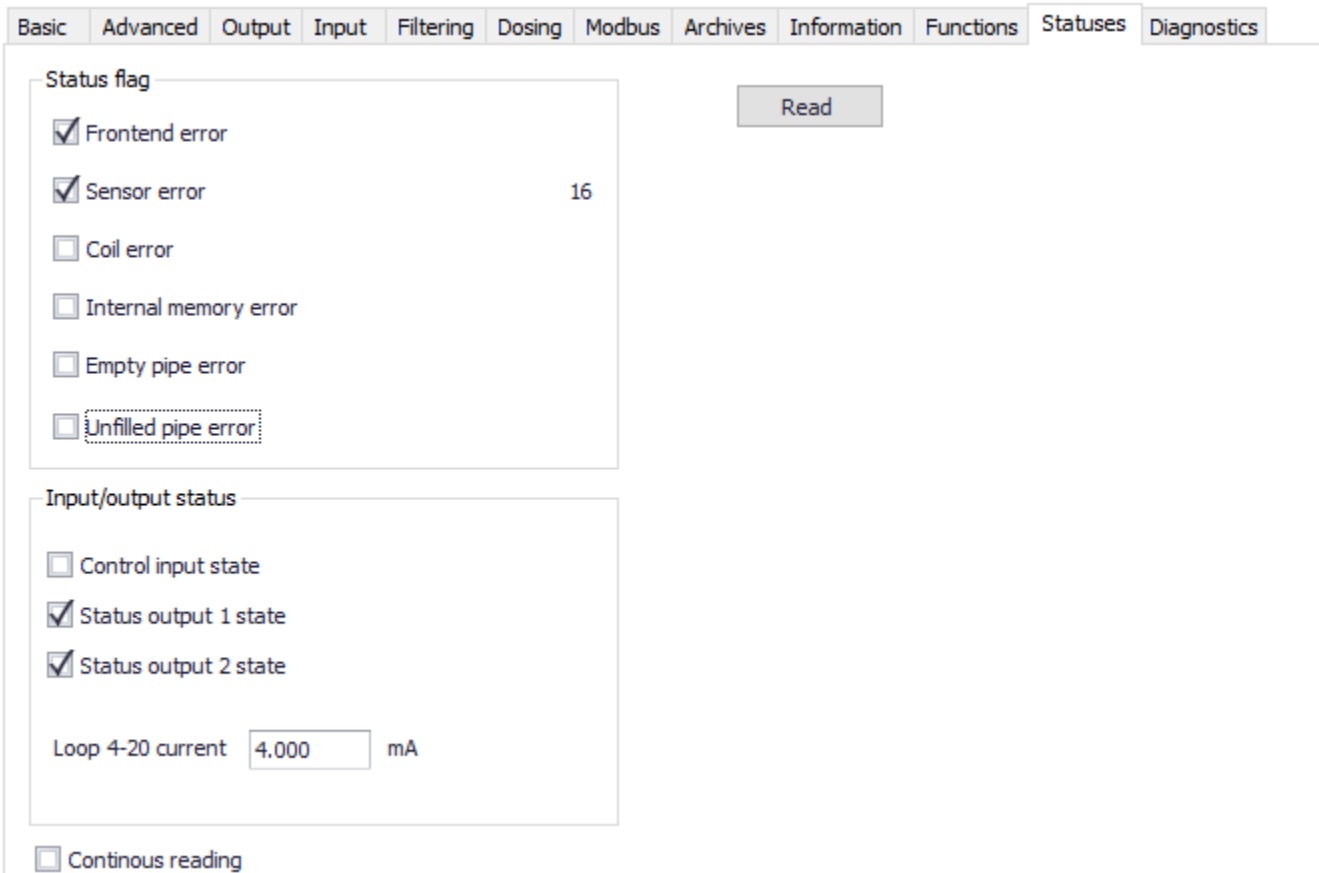

Figure 12. View of the “Statuses” tab in Raport 2.

The field “Status flag” indicates possible faults due to a hardware fault or an incorrect connection. Table 1 lists the possible causes of the errors.

**Table 1.** Error statuses defined in “Raport 2” and their possible causes.

Error status	Possible causes
Measurement board error	General information about error of the measuring board. This error can be caused by: <ol style="list-style-type: none"> <li>1. differential voltage of electrodes exceeded;</li> <li>2. failure of the measuring A/C converter or significant exceeding of its input voltage range;</li> <li>3. Instability of sensor coil current (sensor, wiring, or measuring board damage);</li> <li>4. absolute voltage of measurement electrodes exceeded (almost always due to external factors);</li> <li>5. measuring voltage at the electrodes is exceeded.</li> </ol> Note: Errors 1, 2, 4 and 5 are most often the result of external factors such as contaminated electrodes, lack of liquid, foaming liquid or incorrect grounding of the sensor. The parameters of the system should be checked, because <b><u>usually the measuring plate error is not related to the flowmeter damage.</u></b>
Measurement sensor error	Break in the electrode circuit, error detection based on resistance measurement - hardware failure.
Measuring sensor coil error	Gauge probe coil error Incorrect resistance of the probe coil. Error detection based on resistance measurement - hardware failure or significant excess of the sensor temperature.
Flowmeter Internal memory error	Error in the internal EEPROM memory containing device parameters. Internal SRAM memory storing flowmeter totalizers failed.
Empty pipe detection	At least one of the electrodes is exposed - no medium in the system. Check the parameters of the system because the error is not a hardware failure related to the flowmeter.
*Incomplete pipe detection	Applies to sensors with 3 active electrodes. This error indicates that the third electrode is exposed - the system is not completely filled with media. <b><u>The error is not related to a defect in the flowmeter.</u></b>
*Applies to sensors equipped with 3 active electrodes.	

### Restoring the factory settings and Modbus communication.

If the user disable Modbus communication, the only solution is to restore factory settings of the flowmeter.

To do this, follow these steps:

1. Switch off the power supply;
2. Remove the transmitter enclose and install a jumper on the P3 and P8 connector;
3. Switch on the power supply device and wait for approx. 10 seconds;
4. Switch off the power supply and remove the P3 jumper;
5. Install the transmitter cover;
6. Switch on the power supply.

The device was restored to factory settings and communication via Modbus interface was resumed.

• **Diagnostics**

The tab allows to diagnostics, such as:

- current loop 4-20 mA;
- pulse output;
- binary output.

Furthermore, the user can simulate the flow with a defined value and perform a display test (applies to the version fitted with a display).

**Figure 13.** View of the “Diagnostics” tab in Raport 2.



The content of fields for which setting can be changed or value can be entered are approved using the **Enter** command.  
The **Read** command is used to read the current settings in a specific window.

### 3.3. Preview of data on a virtual display

The “RAPORT 2” software enables viewing information displayed on the display in real time. Below is an example screenshot showing the virtual display of the PEM-500 flowmeter.

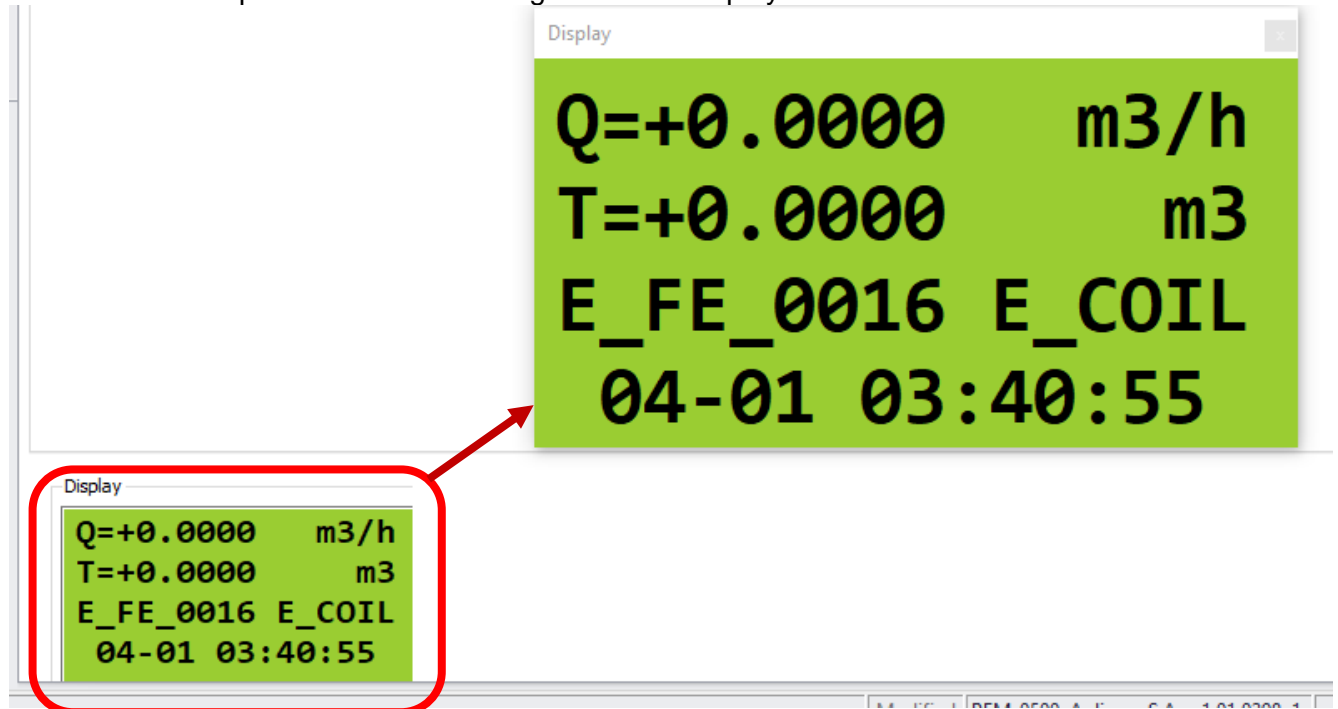

**Figure 14.** Screenshot presenting the current preview of the virtual display of the PEM-500 flowmeter in Raport 2.



## 4. ADDITIONAL INFORMATION

### 4.1. History of revisions

The manufacturer reserves the right to introduce design and process changes in the device not decreasing its performance parameters.



The user manual of flowmeter EN.IO.PEM.500 and MODBUS manual EN.IM.PEM.500 is located on the manufacturer website [www.aplisens.com](http://www.aplisens.com).

### 4.2. History of revisions

Revision No.	Document revision	Description of changes
-	01.A.001/2022.03	First version of the document. Prepared by DBFD.

